

Data sheet | Item number: 769-102/021-000

1-conductor female plug; Locking lever; 4 mm²; 2-pole

769-102/021-000

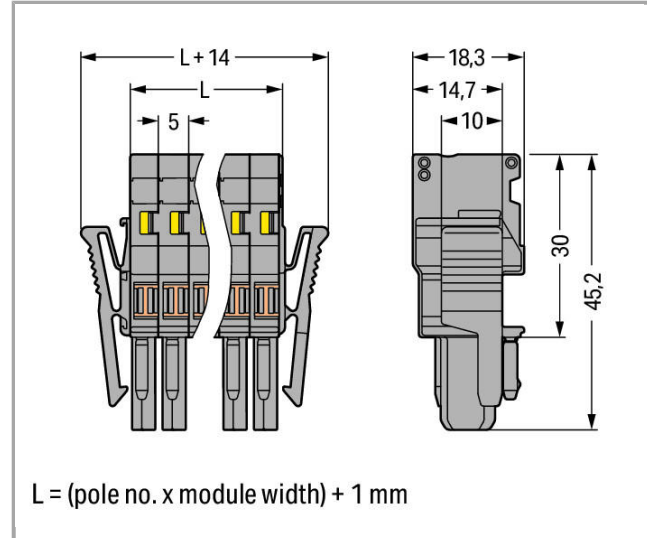
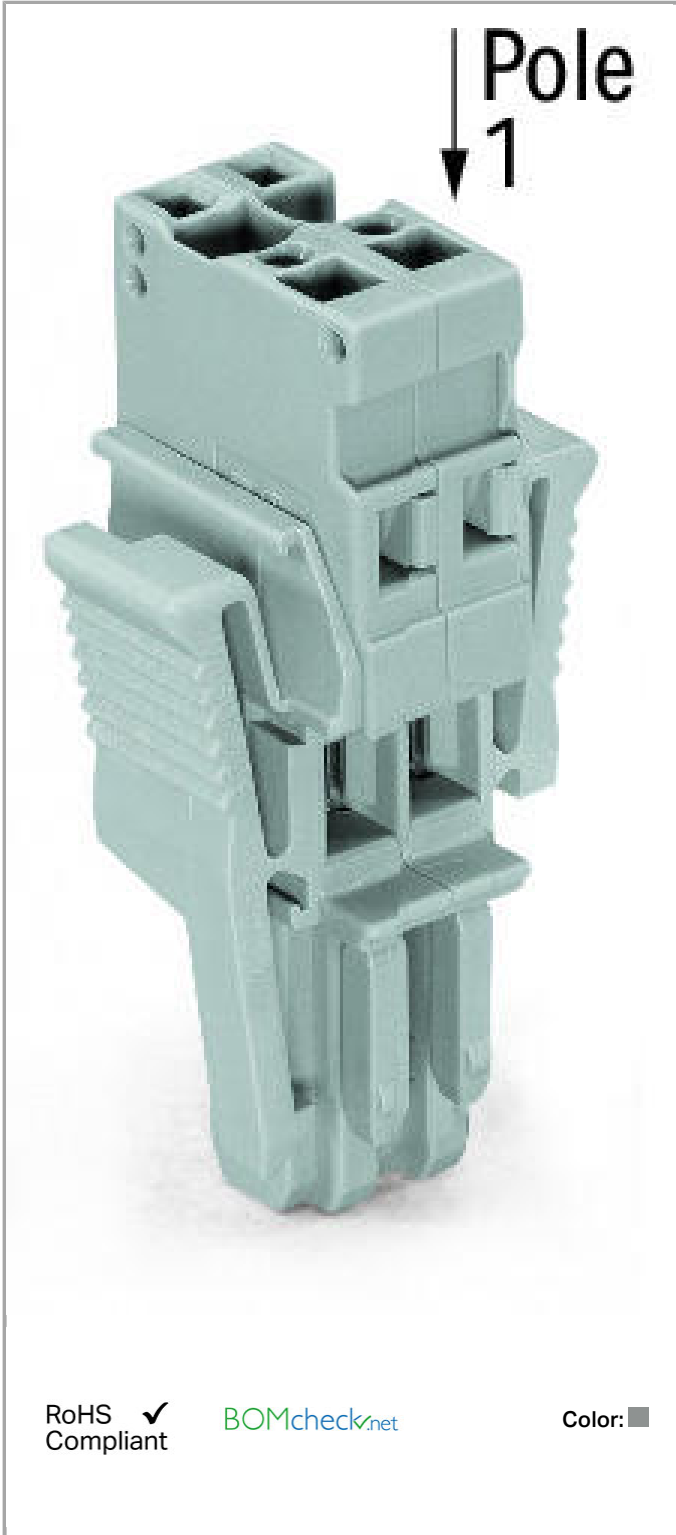

RoHS Compliant

[BOMcheck.net](https://www.bomcheck.net)

Color: ■

Item description

According to EN 61984, pluggable connectors without current interrupting capacity shall not be mated and unmated when live or under load.

Data

Electrical data

Ratings per IEC/EN 60664-1

Rated voltage (III / 3)	500 V
Rated impulse voltage (III / 3)	6 kV
Rated current	32 A

Connection data

Connection technology	CAGE CLAMP®
Actuation type	Operating tool
Connectable conductor materials	Copper
Nominal cross section	4 mm ²
Solid conductor	0.08 ... 4 mm ² / 28 ... 12 AWG
Fine-stranded conductor	0.08 ... 4 mm ² / 28 ... 12 AWG
Strip length	8 ... 9 mm / 0.31 ... 0.35 inch
No. of poles	2
Total number of connection points	2
Total number of potentials	2
Type of wiring	Front-entry wiring

Geometrical Data

Width	25.6 mm / 1.008 inch
Height	45.2 mm / 1.78 inch
Depth	18.3 mm / 0.72 inch
Module width	5 mm / 0.197 inch

Mechanical data

Marking level	Side marking
---------------	--------------

Plug connection

Contact type (pluggable connector)	Female connector/socket
Connector connection type	for conductors

Material Data





Color	gray
Insulating material	Polyamide 66 (PA 66)
Fire load	0.157 MJ
Weight	9.042 g

Commercial data

Product Group	18 (X-COM-System)
Country of origin	DE
GTIN	4044918480697
Customs Tariff No.	85366990990

Approvals / Certificates

Country specific Approvals



Logo	Approval	Additional Approval Text	Certificate name
	CCA DEKRA Certification B.V.	EN 60947	NTR NL-7626
	CCA DEKRA Certification B.V.	EN 61984	2190419.02
	CCA DEKRA Certification B.V.	IEC 61984	NL-47799
	CSA DEKRA Certification B.V.	C22.2 No. 158	1101144
	KEMA/KEUR DEKRA Certification B.V.	EN 60947	2190419.01

Ship Approvals

Logo	Approval	Additional Approval Text	Certificate name
	ABS American Bureau of Shipping	EN 60947	14-HG1293677-PDA

UL-Approvals

Certificate



Logo	Approval	Additional Approval Text	name
	UR Underwriters Laboratories Inc.	UL 1977	E45171
	UR Underwriters Laboratories Inc.	UL 1059	E45172

Compatible products



check

	Item no.: 210-136 Test plug; 2 mm Ø; with 500 mm cable	210-136
	Item no.: 210-137 Test plug; 2.3 mm Ø; with 500 mm cable	210-137

















Insulation stop

	Item no.: 769-470 Insulation stop; 0.08 - 0.2 mm ² "s" (0.14 mm ² "f-st"); 5 pieces/strip	769-470
	Item no.: 769-471 Insulation stop; 0.25 - 0.5 mm ² ; 5 pieces/strip	769-471
	Item no.: 769-472 Insulation stop; 0.75 - 1 mm ² ; 5 pieces/strip	769-472

Locking lever

	Item no.: 769-428 Locking lever	769-428
	Item no.: 769-429 Locking lever	769-429
	Item no.: 769-430 Locking lever	769-430
	Item no.: 769-431 Locking lever	769-431

General accessories

	Item no.: 769-436 Jumper cover; for 1-conductor female plugs; for 5 poles	769-436
Jumper		
	Item no.: 769-402 Miniature adjacent jumper; insulated; suitable for 1-conductor female plugs	769-402
Marking accessories		
	Item no.: 2009-145 Mini-WSB Inline; for Smart Printer; on reel; stretchable 5 - 5.2 mm; plain; snap-on type	2009-145
	Item no.: 2009-145/000-002 Mini-WSB Inline; for Smart Printer; on reel; stretchable 5 - 5.2 mm; plain; snap-on type	2009-145 /000-002
	Item no.: 2009-145/000-005 Mini-WSB Inline; for Smart Printer; on reel; stretchable 5 - 5.2 mm; plain; snap-on type	2009-145 /000-005
	Item no.: 2009-145/000-006 Mini-WSB Inline; for Smart Printer; on reel; stretchable 5 - 5.2 mm; plain; snap-on type	2009-145 /000-006
	Item no.: 2009-145/000-007 Mini-WSB Inline; for Smart Printer; on reel; stretchable 5 - 5.2 mm; plain; snap-on type	2009-145 /000-007
	Item no.: 2009-145/000-012 Mini-WSB Inline; for Smart Printer; on reel; stretchable 5 - 5.2 mm; plain; snap-on type	2009-145 /000-012
	Item no.: 2009-145/000-023 Mini-WSB Inline; for smartPRINTER; on reel; stretchable 5 - 5.2 mm; plain; snap-on type	2009-145 /000-023
	Item no.: 2009-145/000-024 Mini-WSB Inline; for Smart Printer; on reel; stretchable 5 - 5.2 mm; plain; snap-on type	2009-145 /000-024
	Item no.: 210-805 Labels; for Smart Printer	210-805
	Item no.: 210-805/000-002 Labels; for Smart Printer	210-805 /000-002
	Item no.: 210-831 Marking strips; on reel; 2.3 mm wide; plain; Self-adhesive	210-831
	Item no.: 210-832 Marking strips; on reel; 3 mm wide; plain; Self-adhesive	210-832
	Item no.: 210-834 Marking strips; on reel; 5 mm wide; plain; Self-adhesive	210-834
	Item no.: 248-501 Miniature WSB Quick marking system; plain; Marker width 5 mm; 10 strips with 10 markers per card	248-501

	Item no.: 248-501/000-002 Mini-WSB marking card; as card; not stretchable; plain; snap-on type	/000-002	248-501
--	--	----------	---------

	Item no.: 248-501/000-005 Mini-WSB marking card; as card; not stretchable; plain; snap-on type	/000-005	248-501
--	--	----------	---------

	Item no.: 248-501/000-006 Mini-WSB marking card; as card; not stretchable; plain; snap-on type	/000-006	248-501
--	--	----------	---------

	Item no.: 248-501/000-007 Mini-WSB marking card; as card; not stretchable; plain; snap-on type	/000-007	248-501
--	--	----------	---------

	Item no.: 248-501/000-012 Mini-WSB marking card; as card; not stretchable; plain; snap-on type	/000-012	248-501
--	--	----------	---------

	Item no.: 248-501/000-017 Mini-WSB marking card; as card; not stretchable; plain; snap-on type	/000-017	248-501
--	--	----------	---------

	Item no.: 248-501/000-023 Mini-WSB marking card; as card; not stretchable; plain; snap-on type	/000-023	248-501
--	--	----------	---------

	Item no.: 248-501/000-024 Mini-WSB marking card; as card; not stretchable; plain; snap-on type	/000-024	248-501
--	--	----------	---------

Male plug

	Item no.: 769-602 1-conductor male connector; 4 mm ² ; Pin spacing 5 mm; 2-pole		769-602
--	--	--	---------

	Item no.: 769-602/001-000 1-conductor male connector; Snap-in mounting feet; 4 mm ² ; Pin spacing 5 mm; 2-pole	/001-000	769-602
--	---	----------	---------

















	Item no.: 769-602/002-000 1-conductor male connector; clamping collar; 4 mm ² ; Pin spacing 5 mm; 2-pole	/002-000	769-602
--	---	----------	---------





	Item no.: 769-602/004-000 1-conductor male connector; Feedthrough flange; 4 mm ² ; Pin spacing 5 mm; 2-pole	/004-000	769-602
--	--	----------	---------

	Item no.: 769-602/005-000 1-conductor male connector; Snap-in flange; 4 mm ² ; Pin spacing 5 mm; 2-pole	/005-000	769-602
--	--	----------	---------

	Item no.: 769-602/006-000 1-conductor male connector; Snap-in flange; 4 mm ² ; Pin spacing 5 mm; 2-pole	/006-000	769-602
--	--	----------	---------

	Item no.: 769-632 THT male header; 1.0 x 1.0 mm solder pin; straight; Pin spacing 5 mm; 2-pole		769-632
--	--	--	---------

	Item no.: 769-632/000-036 THT male header; 1.0 x 1.0 mm solder pin; straight; Pin spacing 5 mm; 2-pole	769-632 /000-036
	Item no.: 769-632/003-000 THT male header; 1.0 x 1.0 mm solder pin; straight; clamping collar; Pin spacing 5 mm; 2-pole	769-632 /003-000
	Item no.: 769-632/003-036 THT male header; 1.0 x 1.0 mm solder pin; straight; Pin spacing 5 mm; 2-pole	769-632 /003-036
	Item no.: 769-632/004-000 THT male header; 1.0 x 1.0 mm solder pin; straight; Pin spacing 5 mm; 2-pole	769-632 /004-000
	Item no.: 769-632/007-000 THT male header; 1.0 x 1.0 mm solder pin; straight; clamping collar; Pin spacing 5 mm; 2-pole	769-632 /007-000
	Item no.: 769-662 THT male header; 1.0 x 1.0 mm solder pin; angled; Pin spacing 5 mm; 2-pole	769-662
	Item no.: 769-662/003-000 THT male header; 1.0 x 1.0 mm solder pin; angled; clamping collar; Pin spacing 5 mm; 2-pole	769-662 /003-000
	Item no.: 769-662/004-000 THT male header; 1.0 x 1.0 mm solder pin; angled; Pin spacing 5 mm; 2-pole	769-662 /004-000
Protective Warning Marker		
	Item no.: 280-415 Protective warning marker; with high-voltage symbol, black; for 5 terminal blocks	280-415
Strain relief plate		
	Item no.: 769-1602 Strain relief housing	769-1602
	Item no.: 769-411 Strain relief plate	769-411
ferrule		
	Item no.: 216-101 Ferrule; Sleeve for 0.5 mm ² / AWG 22; uninsulated; electro-tin plated	216-101
	Item no.: 216-102 Ferrule; Sleeve for 0.75 mm ² / AWG 20; uninsulated; electro-tin plated	216-102
	Item no.: 216-103 Ferrule; Sleeve for 1 mm ² / AWG 18; uninsulated; electro-tin plated	216-103
	Item no.: 216-104 Ferrule; Sleeve for 1.5 mm ² / AWG 16; uninsulated; electro-tin plated	216-104
	Item no.: 216-201 Ferrule; Sleeve for 0.5 mm ² / 20 AWG; insulated; electro-tin plated	216-201

	Item no.: 216-202 Ferrule; Sleeve for 0.75 mm ² / 18 AWG; insulated; electro-tin plated	216-202
	Item no.: 216-203 Ferrule; Sleeve for 1 mm ² / AWG 18; insulated; electro-tin plated	216-203
	Item no.: 216-204 Ferrule; Sleeve for 1.5 mm ² / AWG 16; insulated; electro-tin plated	216-204
	Item no.: 216-206 Ferrule; Sleeve for 2.5 mm ² / AWG 14; insulated; electro-tin plated	216-206
	Item no.: 216-301 Ferrule; Sleeve for 0.25 mm ² / AWG 24; insulated; electro-tin plated	216-301
	Item no.: 216-302 Ferrule; Sleeve for 0.34 mm ² / 22 AWG; insulated; electro-tin plated	216-302

Downloads

Documentation

Bid Text

769-102/021-000	doc 25.6 kB	Download
-----------------	----------------	----------

CAD/CAE - Smart Data

CAD data

3D Download 769-102/021-000	URL	Download
-----------------------------	-----	----------

Product family

X-COM

[Learn more about the product family.](#)

[Show all products from the family](#)

Subject to changes.